

MC74HC574A

Octal 3-State Noninverting D Flip-Flop

High-Performance Silicon-Gate CMOS

The MC74HC574A is identical in pinout to the LS574. The device inputs are compatible with standard CMOS outputs; with pull-up resistors, they are compatible with LSTTL outputs.

Data meeting the set-up time is clocked to the outputs with the rising edge of the Clock. The Output Enable input does not affect the states of the flip-flops but when Output Enable is high, all device outputs are forced to the high-impedance state. Thus, data may be stored even when the outputs are not enabled.

The HC574A is identical in function to the HC374A but has the flip-flop inputs on the opposite side of the package from the outputs to facilitate PC board layout.

Features

- Output Drive Capability: 15 LSTTL Loads
- Outputs Directly Interface to CMOS, NMOS, and TTL
- Operating Voltage Range: 2.0 to 6.0 V
- Low Input Current: 1.0 μ A
- In Compliance with the Requirements Defined by JEDEC Standard No. 7A
- Chip Complexity: 266 FETs or 66.5 Equivalent Gates
- Pb-Free Packages are Available



ON Semiconductor®

<http://onsemi.com>

MARKING DIAGRAMS

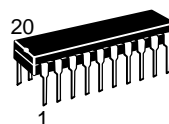

PDIP-20
N SUFFIX
CASE 738

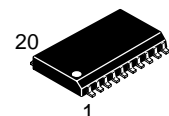
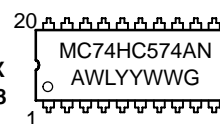

SOIC-20
DW SUFFIX
CASE 751D

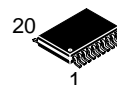
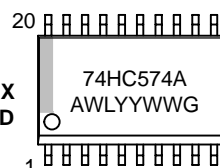

TSSOP-20
DT SUFFIX
CASE 948E

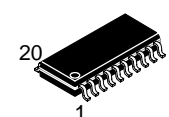
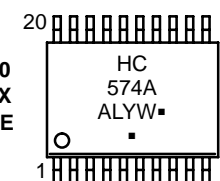

SOEIAJ-20
F SUFFIX
CASE 967

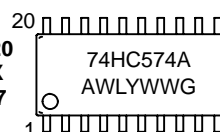

A = Assembly Location
WL, L = Wafer Lot
YY, Y = Year
WW, W = Work Week
G = Pb-Free Package
▪ = Pb-Free Package
(Note: Microdot may be in either location)

ORDERING INFORMATION

See detailed ordering and shipping information in the package dimensions section on page 4 of this data sheet.

*For additional information on our Pb-Free strategy and soldering details, please download the ON Semiconductor Soldering and Mounting Techniques Reference Manual, SOLDERRM/D.

MC74HC574A

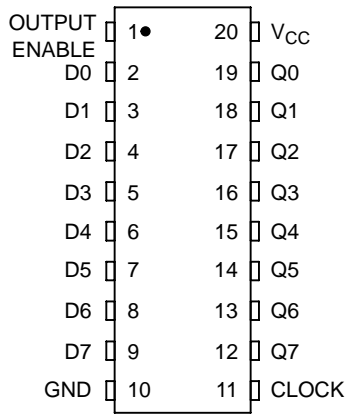

FUNCTION TABLE

Inputs			Output
OE	Clock	D	Q
L		H	H
L		L	L
L	L,H,	X	No Change
H	X	X	Z

X = Don't Care
Z = High Impedance

Figure 1. Pin Assignment

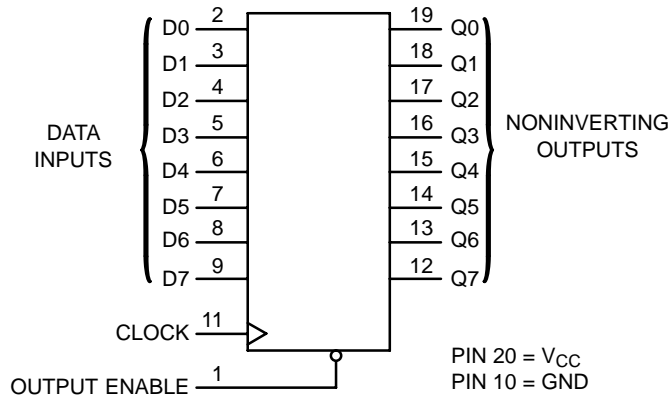

Figure 2. Logic Diagram

Design Criteria	Value	Units
Internal Gate Count*	66.5	ea.
Internal Gate Propagation Delay	1.5	ns
Internal Gate Power Dissipation	5.0	μ W
Speed Power Product	0.0075	pJ

*Equivalent to a two-input NAND gate.

MC74HC574A

MAXIMUM RATINGS

Symbol	Parameter	Value	Unit	
V _{CC}	DC Supply Voltage	-0.5 to +7.0	V	
V _I	DC Input Voltage	-0.5 to V _{CC} + 0.5	V	
V _O	DC Output Voltage (Note 1)	-0.5 to V _{CC} + 0.5	V	
I _{IK}	DC Input Diode Current	±20	mA	
I _{OK}	DC Output Diode Current	±35	mA	
I _O	DC Output Sink Current	±35	mA	
I _{CC}	DC Supply Current per Supply Pin	±75	mA	
I _{GND}	DC Ground Current per Ground Pin	±75	mA	
T _{STG}	Storage Temperature Range	-65 to +150	°C	
T _L	Lead Temperature, 1 mm from Case for 10 Seconds	260	°C	
T _J	Junction Temperature under Bias	+150	°C	
θ _{JA}	Thermal Resistance	PDIP SOIC TSSOP	67 96 128	°C/W
P _D	Power Dissipation in Still Air at 85°C	PDIP SOIC TSSOP	750 500 450	mW
MSL	Moisture Sensitivity	Level 1		
F _R	Flammability Rating	Oxygen Index: 30% – 35%	UL 94 V-0 @ 0.125 in	
V _{ESD}	ESD Withstand Voltage	Human Body Model (Note 2) Machine Model (Note 3) Charged Device Model (Note 4)	>4000 >300 >1000	V
I _{Latchup}	Latchup Performance	Above V _{CC} and Below GND at 85°C (Note 5)	±300	mA

Maximum ratings are those values beyond which device damage can occur. Maximum ratings applied to the device are individual stress limit values (not normal operating conditions) and are not valid simultaneously. If these limits are exceeded, device functional operation is not implied, damage may occur and reliability may be affected.

1. I_O absolute maximum rating must be observed.
2. Tested to EIA/JESD22-A114-A.
3. Tested to EIA/JESD22-A115-A.
4. Tested to JESD22-C101-A.
5. Tested to EIA/JESD78.
6. For high frequency or heavy load considerations, see the ON Semiconductor High-Speed CMOS Data Book (DL129/D).

RECOMMENDED OPERATING CONDITIONS

Symbol	Parameter	Min	Max	Unit
V _{CC}	DC Supply Voltage (Referenced to GND)	2.0	6.0	V
V _I , V _O	DC Input Voltage, Output Voltage (Referenced to GND)	0	V _{CC}	V
T _A	Operating Temperature, All Package Types	-55	+125	°C
t _r , t _f	Input Rise and Fall Time (Figure 3)	V _{CC} = 2.0 V V _{CC} = 4.5 V V _{CC} = 6.0 V	0 1000 500 400	ns

7. Unused inputs may not be left open. All inputs must be tied to a high- or low-logic input voltage level.

MC74HC574A

ORDERING INFORMATION

Device	Package	Shipping†
MC74HC574AN	PDIP–20	18 Units / Box
MC74HC574ANG	PDIP–20 (Pb–Free)	18 Units / Box
MC74HC574ADW	SOIC–20 WIDE	38 Units / Rail
MC74HC574ADWG	SOIC–20 WIDE (Pb–Free)	38 Units / Rail
MC74HC574ADWR2	SOIC–20 WIDE	1000 Tape & Reel
MC74HC574ADWR2G	SOIC–20 WIDE (Pb–Free)	1000 Tape & Reel
MC74HC574ADTR2	TSSOP–20*	2500 Tape & Reel
MC74HC574ADTR2G	TSSOP–20*	2500 Tape & Reel
MC74HC574AF	SOEIAJ–20	40 Units / Rail
MC74HC574AFG	SOEIAJ–20 (Pb–Free)	40 Units / Rail
MC74HC574AFEL	SOEIAJ–20	2000 Tape & Reel
MC74HC574AFELG	SOEIAJ–20 (Pb–Free)	2000 Tape & Reel

†For information on tape and reel specifications, including part orientation and tape sizes, please refer to our Tape and Reel Packaging Specifications Brochure, BRD8011/D.

*This package is inherently Pb–Free.

DC ELECTRICAL CHARACTERISTICS (Voltages Referenced to GND)

Symbol	Parameter	Test Conditions	V _{CC} V	Guaranteed Limit			Unit
				–55 to 25°C	≤ 85°C	≤ 125°C	
V _{IH}	Minimum High–Level Input Voltage	V _{out} = V _{CC} – 0.1 V I _{out} ≤ 20 μA	2.0	1.5	1.5	1.5	V
			3.0	2.1	2.1	2.1	
			4.5	3.15	3.15	3.15	
			6.0	4.2	4.2	4.2	
V _{IL}	Maximum Low–Level Input Voltage	V _{out} = 0.1 V I _{out} ≤ 20 μA	2.0	0.5	0.5	0.5	V
			3.0	0.9	0.9	0.9	
			4.5	1.35	1.35	1.35	
			6.0	1.8	1.8	1.8	
V _{OH}	Minimum High–Level Output Voltage	V _{in} = V _{IH} I _{out} ≤ 20 μA	2.0	1.9	1.9	1.9	V
			4.5	4.4	4.4	4.4	
			6.0	5.9	5.9	5.9	
V _{OH}	Minimum High–Level Output Voltage	V _{in} = V _{IH} I _{out} ≤ 2.4 mA I _{out} ≤ 6.0 mA I _{out} ≤ 7.8 mA	3.0	2.48	2.34	2.2	V
			4.5	3.98	3.84	3.7	
			6.0	5.48	5.34	5.2	
V _{OL}	Maximum Low–Level Output Voltage	V _{in} = V _{IL} I _{out} ≤ 20 μA	2.0	0.1	0.1	0.1	V
			4.5	0.1	0.1	0.1	
			6.0	0.1	0.1	0.1	
		V _{in} = V _{IL} I _{out} ≤ 2.4 mA I _{out} ≤ 6.0 mA I _{out} ≤ 7.8 mA	3.0	0.26	0.33	0.4	
			4.5	0.26	0.33	0.4	
			6.0	0.26	0.33	0.4	
I _{in}	Maximum Input Leakage Current	V _{in} = V _{CC} or GND	6.0	± 0.1	± 1.0	± 1.0	μA
I _{OZ}	Maximum Three–State Leakage Current	Output in High–Impedance State V _{in} = V _{IL} or V _{IH} V _{out} = V _{CC} or GND	6.0	± 0.5	± 5.0	± 10	μA
I _{CC}	Maximum Quiescent Supply Current (per Package)	V _{in} = V _{CC} or GND I _{out} = 0 μA	6.0	4.0	40	160	μA

8. Information on typical parametric values can be found in the ON Semiconductor High–Speed CMOS Data Book (DL129/D).

MC74HC574A

AC ELECTRICAL CHARACTERISTICS (C_L = 50 pF; Input t_r = t_f = 6.0 ns)

Symbol	Parameter	V _{CC} V	Guaranteed Limit			Unit
			-55 to 25°C	≤ 85°C	≤ 125°C	
f _{max}	Maximum Clock Frequency (50% Duty Cycle) (Figures 3 and 6)	2.0	6.0	4.8	4.0	MHz
		3.0	15	10	8.0	
		4.5	30	24	20	
		6.0	35	28	24	
t _{PLH} , t _{PHL}	Maximum Propagation Delay, Clock to Q (Figures 3 and 6)	2.0	160	200	240	ns
		3.0	105	145	190	
		4.5	32	40	48	
		6.0	27	34	41	
t _{PLZ} , t _{PHZ}	Maximum Propagation Delay, Output Enable to Q (Figures 4 and 7)	2.0	150	190	225	ns
		3.0	100	125	150	
		4.5	30	38	45	
		6.0	26	33	38	
t _{PZL} , t _{PZH}	Maximum Propagation Delay, Output Enable to Q (Figures 4 and 7)	2.0	140	175	210	ns
		3.0	90	120	140	
		4.5	28	35	42	
		6.0	24	30	36	
t _{TLH} , t _{THL}	Maximum Output Transition Time, any Output (Figures 3 and 6)	2.0	60	75	90	ns
		3.0	27	32	36	
		4.5	12	15	18	
		6.0	10	13	15	
C _{in}	Maximum Input Capacitance		10	10	10	pF
C _{out}	Maximum Three-State Output Capacitance, Output in High-Impedance State		15	15	15	pF

9. For propagation delays with loads other than 50 pF, and information on typical parametric values, see the ON Semiconductor High-Speed CMOS Data Book (DL129/D).

C _{PD}	Power Dissipation Capacitance (Per Enabled Output)*	Typical @ 25°C, V _{CC} = 5.0 V		pF
		24		

*Used to determine the no-load dynamic power consumption: P_D = C_{PD} V_{CC}²f + I_{CC} V_{CC}. For load considerations, see the ON Semiconductor High-Speed CMOS Data Book (DL129/D).

TIMING REQUIREMENTS (C_L = 50 pF; Input t_r = t_f = 6.0 ns)

Symbol	Parameter	Figure	V _{CC} Volts	Guaranteed Limit						Unit
				-55 to 25°C		≤ 85°C		≤ 125°C		
				Min	Max	Min	Max	Min	Max	
t _{su}	Minimum Setup Time, Data to Clock	5	2.0	50		65		75		ns
			3.0	40		50		60		
			4.5	10		13		15		
			6.0	9.0		11		13		
t _h	Minimum Hold Time, Clock to Data	5	2.0	5.0		5.0		5.0		ns
			3.0	5.0		5.0		5.0		
			4.5	5.0		5.0		5.0		
			6.0	5.0		5.0		5.0		
t _w	Minimum Pulse Width, Clock	3	2.0	75		95		110		ns
			3.0	60		80		90		
			4.5	15		19		22		
			6.0	13		16		19		
t _p , t _f	Maximum Input Rise and Fall Times	3	2.0		1000		1000		1000	ns
			3.0		800		800		800	
			4.5		500		500		500	
			6.0		400		400		400	

MC74HC574A

SWITCHING WAVEFORMS

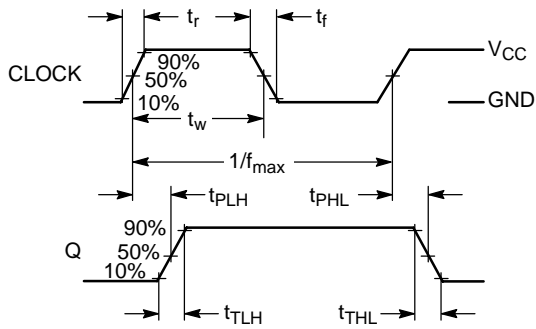

Figure 3.

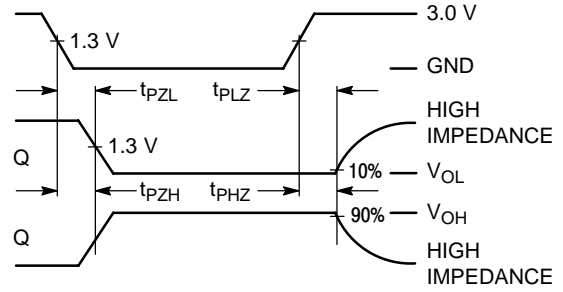

Figure 4.

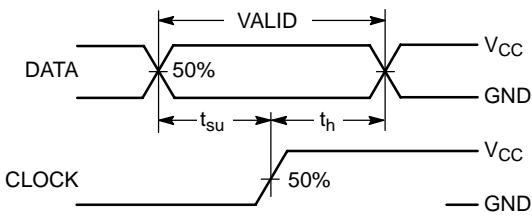
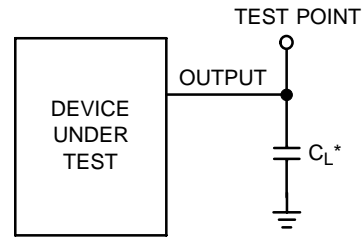
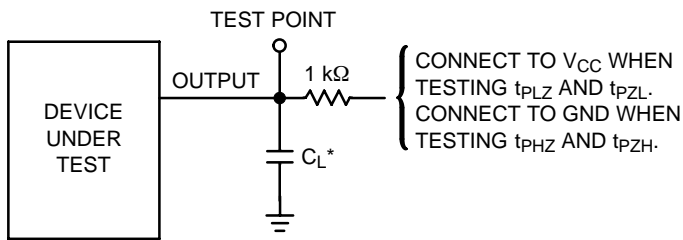

Figure 5.



*Includes all probe and jig capacitance.

Figure 6.



*Includes all probe and jig capacitance.

Figure 7. Test Circuit

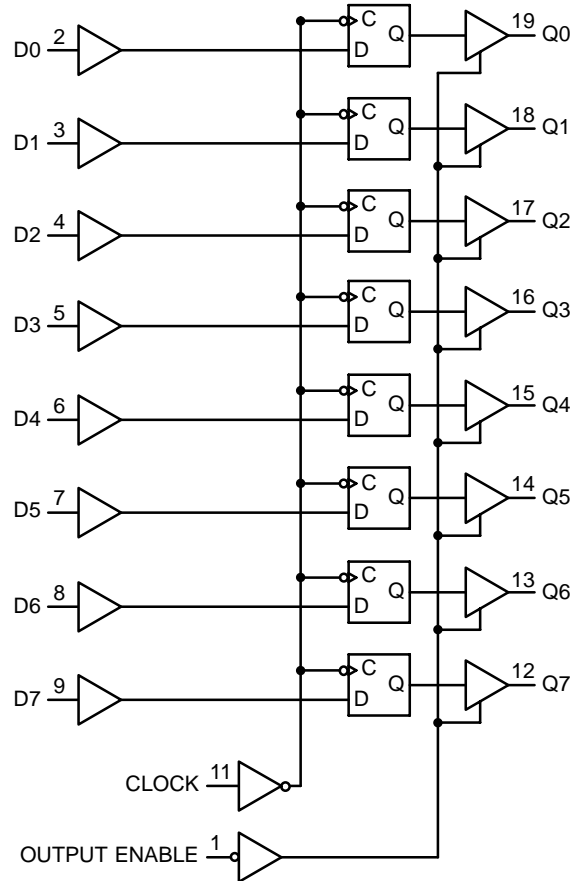
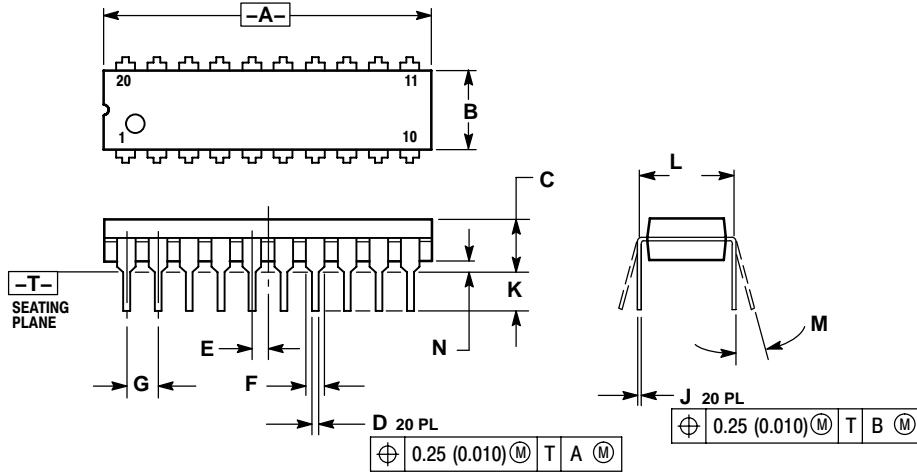

Figure 8. Expanded Logic Diagram

MC74HC574A

PACKAGE DIMENSIONS

PDIP-20
N SUFFIX
PLASTIC DIP PACKAGE
CASE 738-03
ISSUE E



- NOTES:
1. DIMENSIONING AND TOLERANCING PER ANSI Y14.5M, 1982.
 2. CONTROLLING DIMENSION: INCH.
 3. DIMENSION L TO CENTER OF LEAD WHEN FORMED PARALLEL.
 4. DIMENSION B DOES NOT INCLUDE MOLD FLASH.

DIM	INCHES		MILLIMETERS	
	MIN	MAX	MIN	MAX
A	1.010	1.070	25.66	27.17
B	0.240	0.260	6.10	6.60
C	0.150	0.180	3.81	4.57
D	0.015	0.022	0.39	0.55
E	0.050 BSC		1.27 BSC	
F	0.050	0.070	1.27	1.77
G	0.100 BSC		2.54 BSC	
J	0.008	0.015	0.21	0.38
K	0.110	0.140	2.80	3.55
L	0.300 BSC		7.62 BSC	
M	0°	15°	0°	15°
N	0.020	0.040	0.51	1.01

SOIC-20
DW SUFFIX
CASE 751D-05
ISSUE G

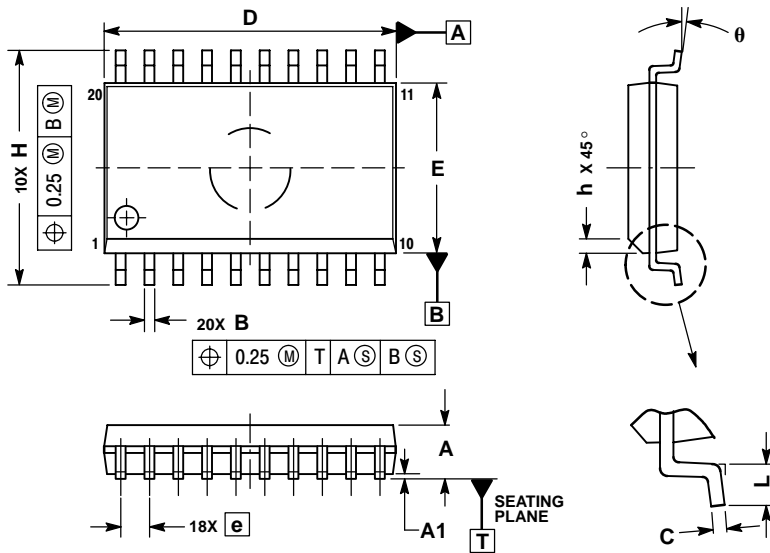

- NOTES:
1. DIMENSIONS ARE IN MILLIMETERS.
 2. INTERPRET DIMENSIONS AND TOLERANCES PER ASME Y14.5M, 1994.
 3. DIMENSIONS D AND E DO NOT INCLUDE MOLD PROTRUSION.
 4. MAXIMUM MOLD PROTRUSION 0.15 PER SIDE.
 5. DIMENSION B DOES NOT INCLUDE DAMBAR PROTRUSION. ALLOWABLE PROTRUSION SHALL BE 0.13 TOTAL IN EXCESS OF B DIMENSION AT MAXIMUM MATERIAL CONDITION.

DIM	MILLIMETERS	
	MIN	MAX
A	2.35	2.65
A1	0.10	0.25
B	0.35	0.49
C	0.23	0.32
D	12.65	12.95
E	7.40	7.60
e		1.27 BSC
H	10.05	10.55
h	0.25	0.75
L	0.50	0.90
theta	0°	7°

MC74HC574A

PACKAGE DIMENSIONS

TSSOP-20
DT SUFFIX
20 PIN PLASTIC TSSOP PACKAGE
CASE 948E-02
ISSUE B

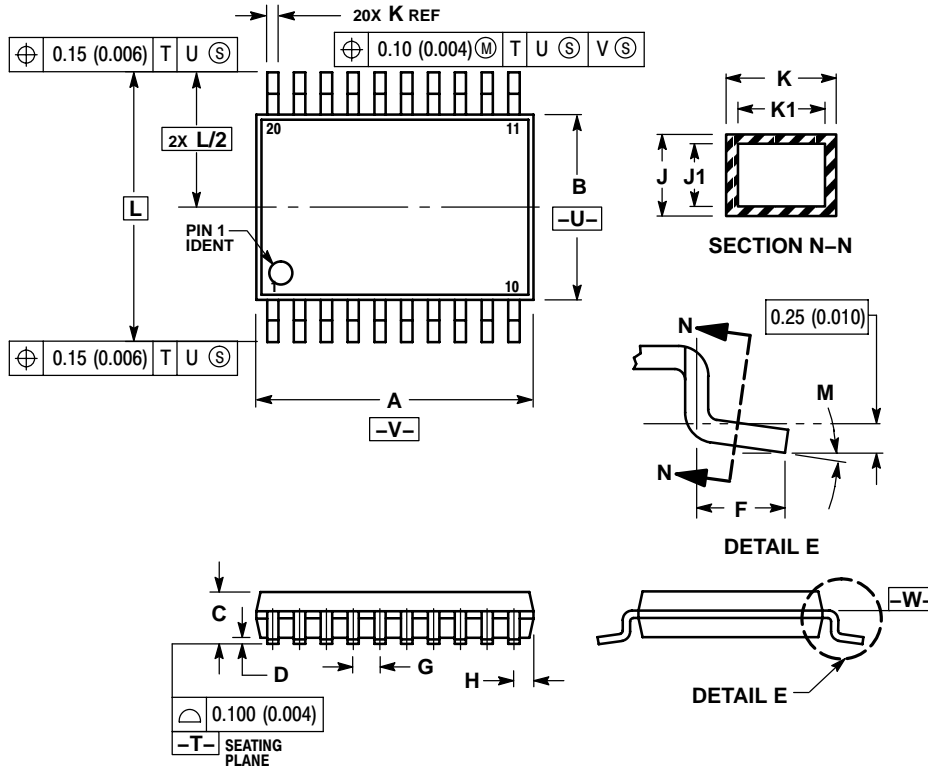

NOTES:

1. DIMENSIONING AND TOLERANCING PER ANSI Y14.5M, 1982.
2. CONTROLLING DIMENSION: MILLIMETER.
3. DIMENSION A DOES NOT INCLUDE MOLD FLASH, PROTRUSIONS OR GATE BURRS. MOLD FLASH OR GATE BURRS SHALL NOT EXCEED 0.15 (0.006) PER SIDE.
4. DIMENSION B DOES NOT INCLUDE INTERLEAD FLASH OR PROTRUSION. INTERLEAD FLASH OR PROTRUSION SHALL NOT EXCEED 0.25 (0.010) PER SIDE.
5. DIMENSION K DOES NOT INCLUDE DAMBAR PROTRUSION. ALLOWABLE DAMBAR PROTRUSION SHALL BE 0.08 (0.003) TOTAL IN EXCESS OF THE K DIMENSION AT MAXIMUM MATERIAL CONDITION.
6. TERMINAL NUMBERS ARE SHOWN FOR REFERENCE ONLY.
7. DIMENSION A AND B ARE TO BE DETERMINED AT DATUM PLANE -W-.

DIM	MILLIMETERS		INCHES	
	MIN	MAX	MIN	MAX
A	6.40	6.60	0.252	0.260
B	4.30	4.50	0.169	0.177
C	---	1.20	---	0.047
D	0.05	0.15	0.002	0.006
F	0.50	0.75	0.020	0.030
G	0.65 BSC		0.026 BSC	
H	0.27	0.37	0.011	0.015
J	0.09	0.20	0.004	0.008
J1	0.09	0.16	0.004	0.006
K	0.19	0.30	0.007	0.012
K1	0.19	0.25	0.007	0.010
L	6.40 BSC		0.252 BSC	
M	0°	8°	0°	8°

MC74HC574A

PACKAGE DIMENSIONS

SOEIAJ-20
F SUFFIX
CASE 967-01
ISSUE O

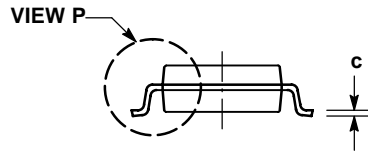
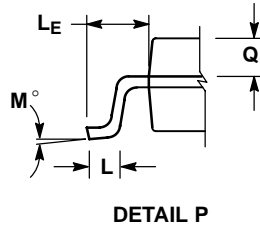
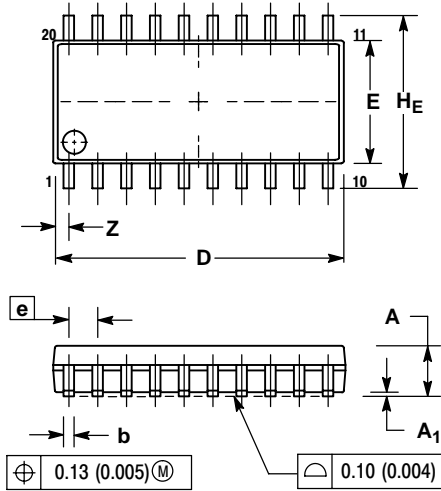

NOTES:

1. DIMENSIONING AND TOLERANCING PER ANSI Y14.5M, 1982.
2. CONTROLLING DIMENSION: MILLIMETER.
3. DIMENSIONS D AND E DO NOT INCLUDE MOLD FLASH OR PROTRUSIONS AND ARE MEASURED AT THE PARTING LINE. MOLD FLASH OR PROTRUSIONS SHALL NOT EXCEED 0.15 (0.006) PER SIDE.
4. TERMINAL NUMBERS ARE SHOWN FOR REFERENCE ONLY.
5. THE LEAD WIDTH DIMENSION (b) DOES NOT INCLUDE DAMBAR PROTRUSION. ALLOWABLE DAMBAR PROTRUSION SHALL BE 0.08 (0.003) TOTAL IN EXCESS OF THE LEAD WIDTH DIMENSION AT MAXIMUM MATERIAL CONDITION. DAMBAR CANNOT BE LOCATED ON THE LOWER RADIUS OR THE FOOT. MINIMUM SPACE BETWEEN PROTRUSIONS AND ADJACENT LEAD TO BE 0.46 (0.018).

DIM	MILLIMETERS		INCHES	
	MIN	MAX	MIN	MAX
A	---	2.05	---	0.081
A ₁	0.05	0.20	0.002	0.008
b	0.35	0.50	0.014	0.020
c	0.18	0.27	0.007	0.011
D	12.35	12.80	0.486	0.504
E	5.10	5.45	0.201	0.215
e	1.27 BSC		0.050 BSC	
HE	7.40	8.20	0.291	0.323
LE	0.50	0.85	0.020	0.033
LF	1.10	1.50	0.043	0.059
M	0°	10°	0°	10°
Q ₁	0.70	0.90	0.028	0.035
Z	---	0.81	---	0.032

MC74HC574A

ON Semiconductor and **ON** are registered trademarks of Semiconductor Components Industries, LLC (SCILLC). SCILLC reserves the right to make changes without further notice to any products herein. SCILLC makes no warranty, representation or guarantee regarding the suitability of its products for any particular purpose, nor does SCILLC assume any liability arising out of the application or use of any product or circuit, and specifically disclaims any and all liability, including without limitation special, consequential or incidental damages. "Typical" parameters which may be provided in SCILLC data sheets and/or specifications can and do vary in different applications and actual performance may vary over time. All operating parameters, including "Typicals" must be validated for each customer application by customer's technical experts. SCILLC does not convey any license under its patent rights nor the rights of others. SCILLC products are not designed, intended, or authorized for use as components in systems intended for surgical implant into the body, or other applications intended to support or sustain life, or for any other application in which the failure of the SCILLC product could create a situation where personal injury or death may occur. Should Buyer purchase or use SCILLC products for any such unintended or unauthorized application, Buyer shall indemnify and hold SCILLC and its officers, employees, subsidiaries, affiliates, and distributors harmless against all claims, costs, damages, and expenses, and reasonable attorney fees arising out of, directly or indirectly, any claim of personal injury or death associated with such unintended or unauthorized use, even if such claim alleges that SCILLC was negligent regarding the design or manufacture of the part. SCILLC is an Equal Opportunity/Affirmative Action Employer. This literature is subject to all applicable copyright laws and is not for resale in any manner.

PUBLICATION ORDERING INFORMATION

LITERATURE FULFILLMENT:

Literature Distribution Center for ON Semiconductor
P.O. Box 61312, Phoenix, Arizona 85082-1312 USA
Phone: 480-829-7710 or 800-344-3860 Toll Free USA/Canada
Fax: 480-829-7709 or 800-344-3867 Toll Free USA/Canada
Email: orderlit@onsemi.com

N. American Technical Support: 800-282-9855 Toll Free
USA/Canada

Japan: ON Semiconductor, Japan Customer Focus Center
2-9-1 Kamimeguro, Meguro-ku, Tokyo, Japan 153-0051
Phone: 81-3-5773-3850

ON Semiconductor Website: <http://onsemi.com>

Order Literature: <http://www.onsemi.com/litorder>

For additional information, please contact your
local Sales Representative.

MC74HC574A/D